

Capacidade de Carga - Load Capacity - Capacidad de carga

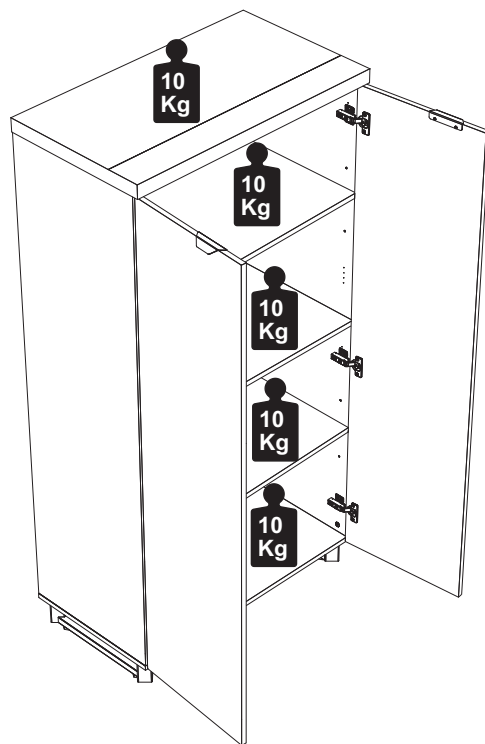

Manutenção e Limpeza

Vidros: pano levemente umedecido com álcool, seguido de pano seco.
Madeiras: pano levemente umedecido com água, seguido de pano seco.
*Nunca utilizar produtos químicos ou abrasivos.

Maintenance and Cleaning

Glasses: cloth lightly moistened with alcohol, followed by dry cloth.
Woods: cloth slightly moistened with water, followed by cloth seco.
*Never use chemicals or abrasives.

Mantenimiento y Limpieza

Vidrios: legeramente humedecido con alcohol, seguido de un paño seco.
Madera: ligeramente humedecido con agua, seguido de un paño seco.
*No utilice nunca productos quimicos o abrasivos.

INSTRUÇÕES DE MONTAGEM ASSEMBLY INSTRUCTIONS INSTRUCCIONES DE MONTAJE

ARMÁRIO ALTO

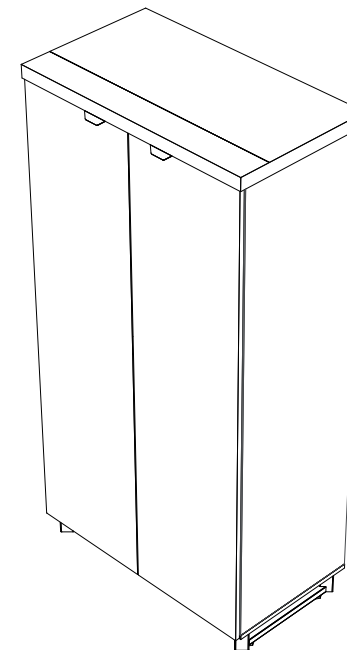

REF. #BOS8016

 **Gebbwork**
MOBILIÁRIO

GEBB Work Ind. de Móveis Ltda.
Rua Felix Roman, 190
São Valentin
95709-170 - Bento Gonçalves - RS - Brasil Fone: (0XX54) 3454-1105 - (0XX54) 3453-1407 Phone: (0XX54) 3454-1105 - (0XX54) 3453-1407 E-mail: pedidos@gebbwork.com.br
www.gebbwork.com.br
WhatsApp: +55 54 99177-8324
REV.: 01 - 05/04/2025



LISTA DE PEÇAS

PART LIST LISTA DE PIEZAS

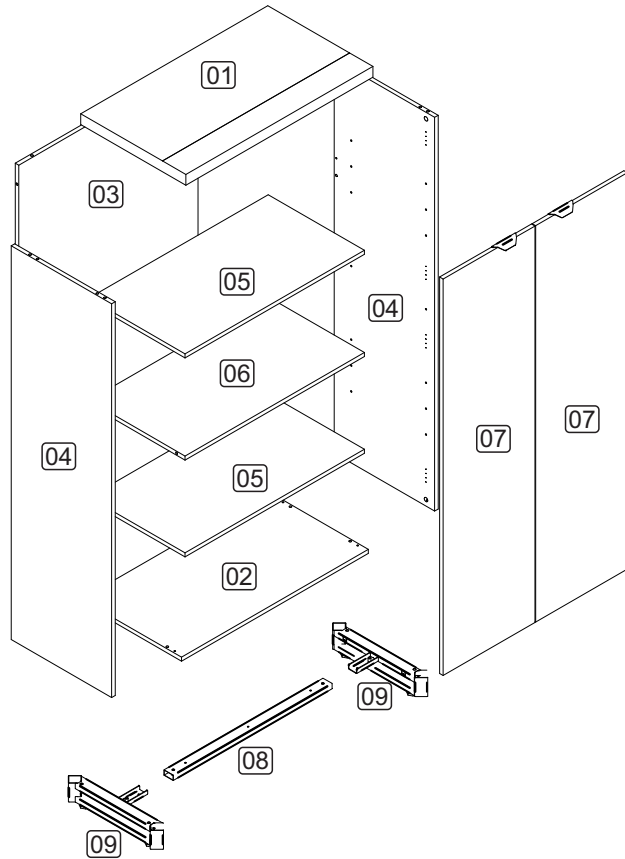

LISTA DE PEÇAS

01 - Tampo
02 - Base
03 - Costa
04 - Lateral Dir/Esq
05 - Prateleira Móvel
06 - Prateleira Fixa
07 - Porta
08 - Longarina Rodapé
09 - Rodapé Metálico

LISTA DE PIEZAS

(1x) 01 - Tapa
(1x) 02 - Base
(1x) 03 - Revés
(2x) 04 - Lateral Derecha/Izquierda
(2x) 05 - Plataforma Mueve
(1x) 06 - Plataforma Fija
(2x) 07 - Puerta
(1x) 08 - Larguero
(2x) 09 - Zócalo

PARTS IDENTIFICATION

(1x) 01 - Top Ppanel
(1x) 02 - Botton Panel
(1x) 03 - Back Panel
(2x) 04 - Right/Left Side Pnel
(2x) 05 - Mobile Shelf
(1x) 06 - Fixed Shelf
(2x) 07 - Door
(1x) 08 - Metal Spar
(2x) 09 - Metal Skirting Board

ACESSÓRIOS

ACCESSORIES ACCESORIOS

A8 - PARAF. 4,0x14 CP
40x



A35 - TAMBOR MINIFIX
18x



G1 - DOBRADIÇA
CANECO 35 BAIXO **6x**

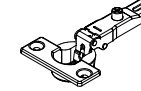

D1 - CAVILHA 8x30
20x

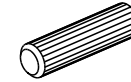

B1 - SUPORTE PRAT.
METÁLICO **8x**

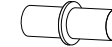

A13 - PARAF. 4,0x30 CP
3x



A32 - PARAF. MINIFIX
18x

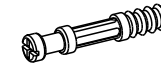

A44 - PARAF. M6x16 CP
02x



L2 - SAPATA PLAST.
SEXT. **4x**



L5 - BUCHA PLÁSTICA
P/SAPATA 5/16 **4x**



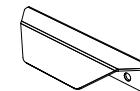

C11 - PUXARDOR
MET. BOSS
2x



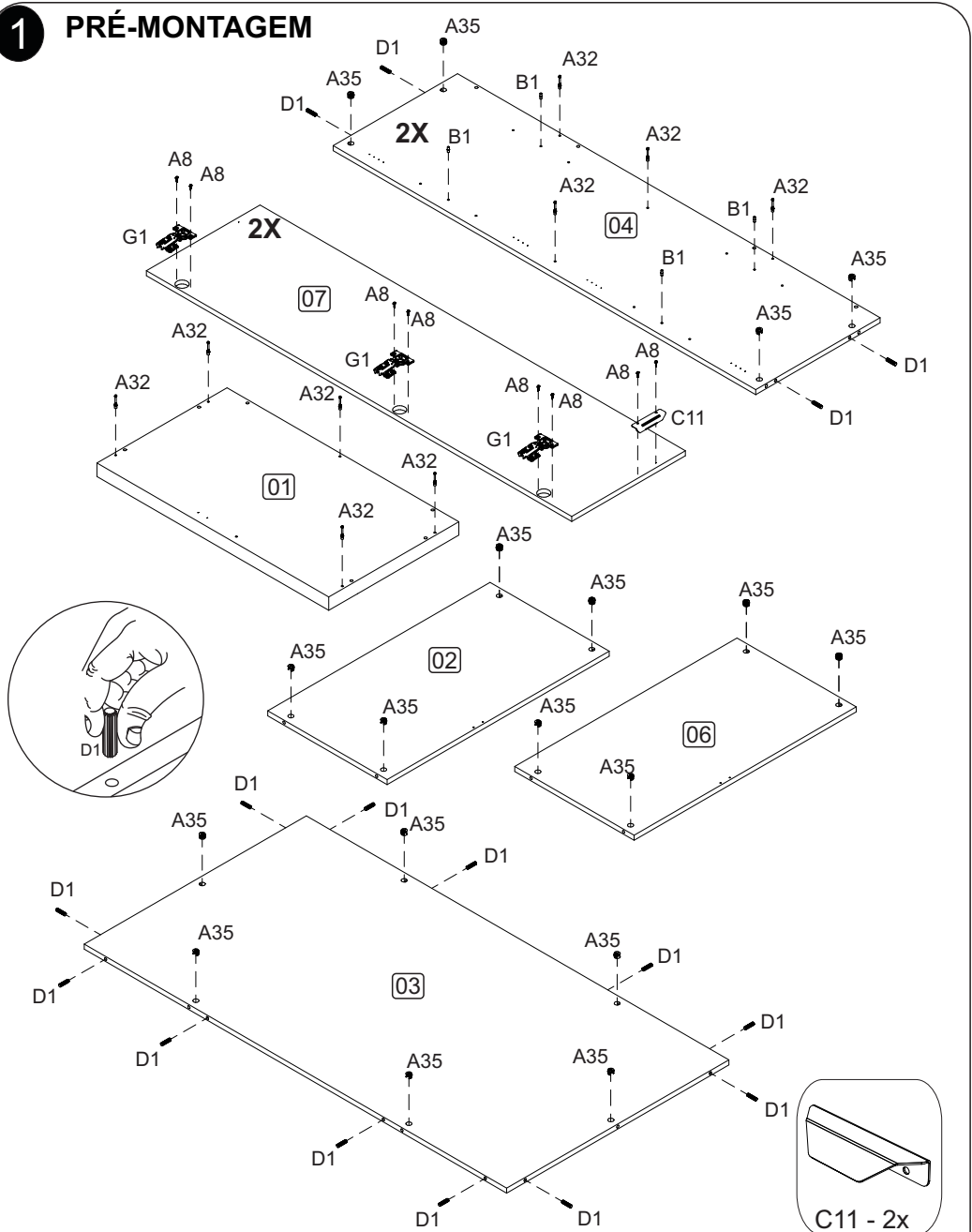

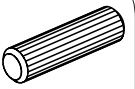
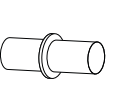
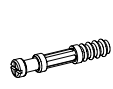
1 PRÉ-MONTAGEM

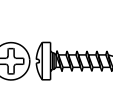
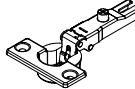

- 
D1 - 20x
- 
B1 - 8x
- 
A32 - 18x
- 
A35 - 18x
- 
A8 - 16x
- 
G1 - 6x

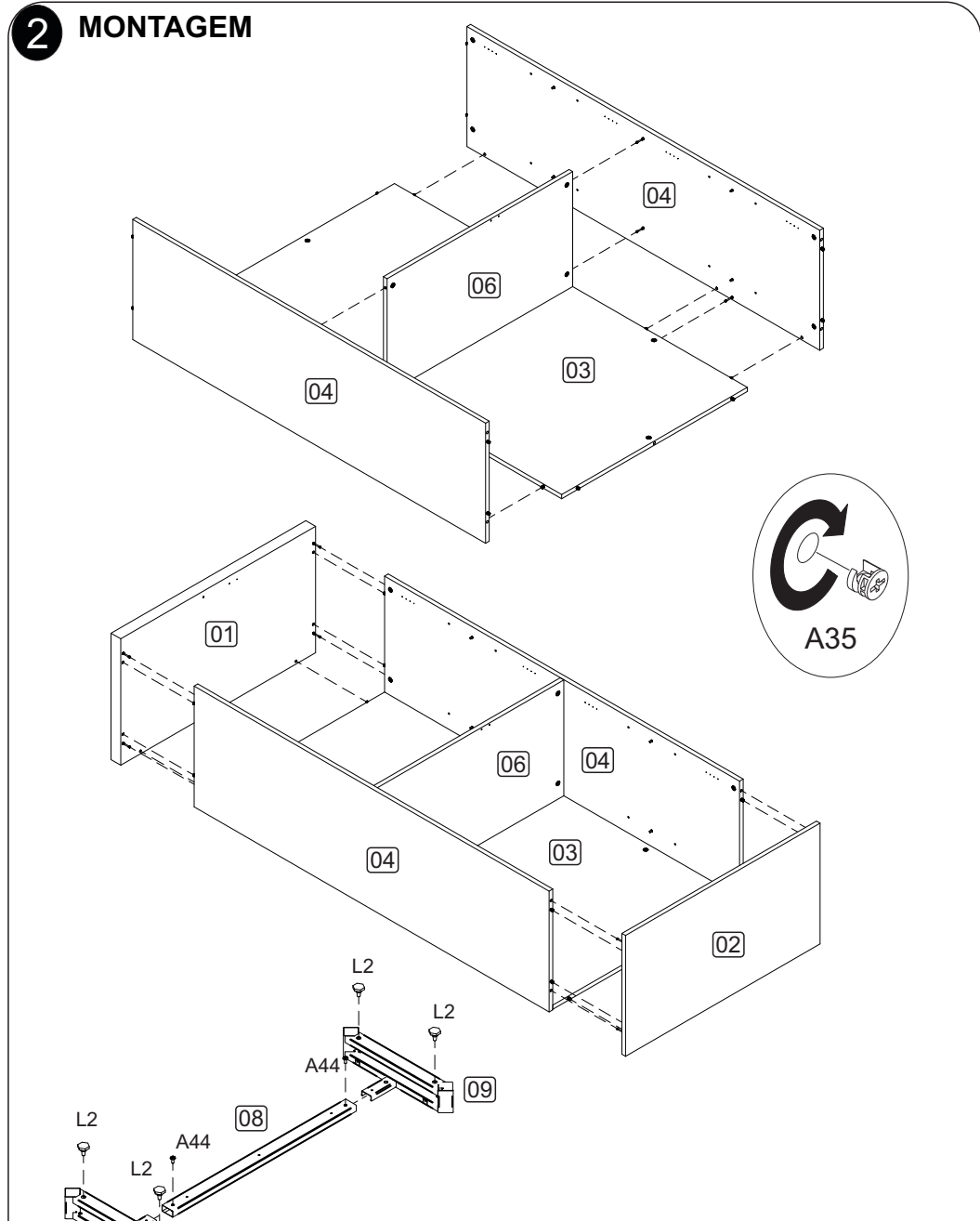
2 MONTAGEM

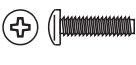

- 
L2 - 4x
- 
L5 - 4x
- 
A44 - 2x

3

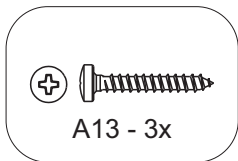
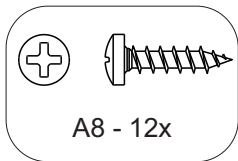
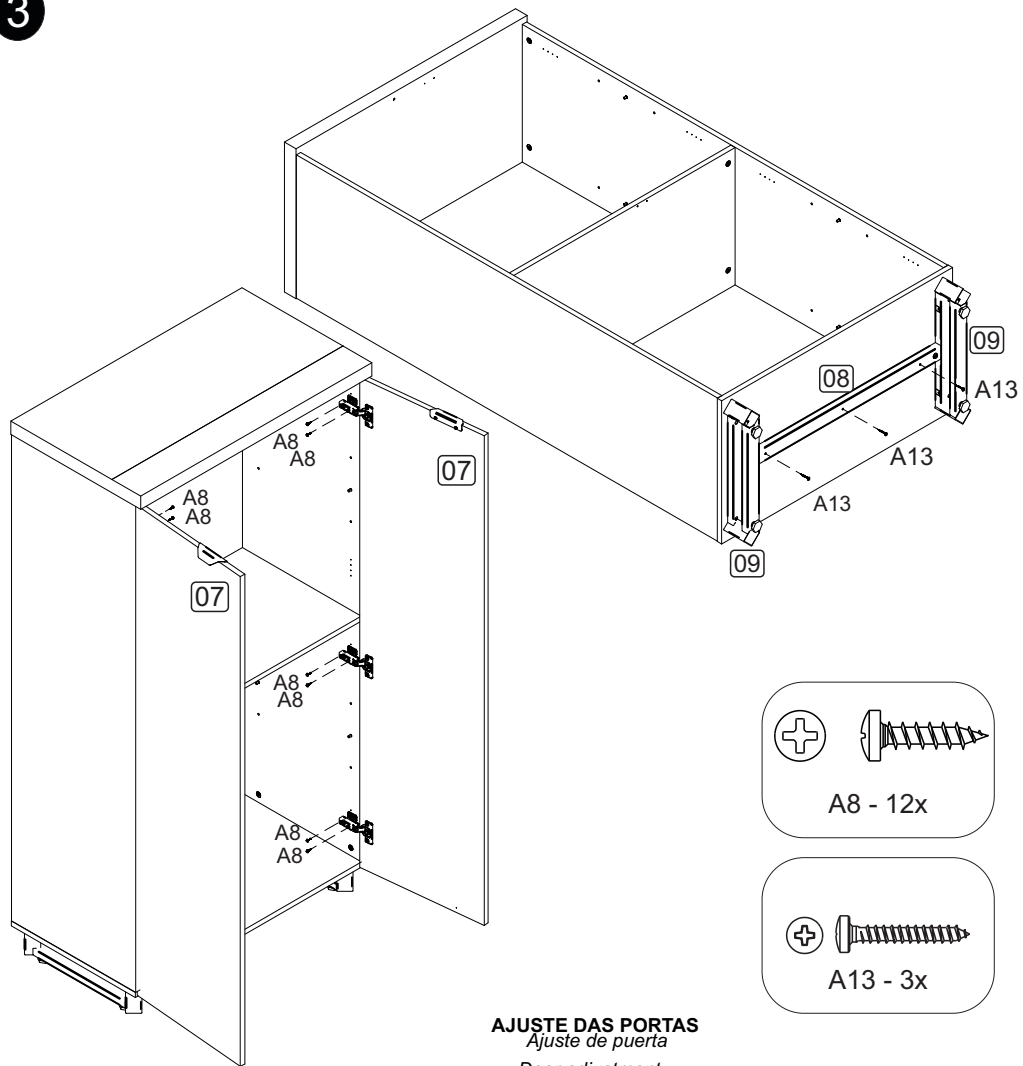

AJUSTE DAS PORTAS
Ajuste de puerta
Door adjustment

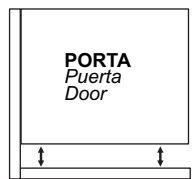

AJUSTE DE ALTURA
Ajuste de altura
Height adjustment

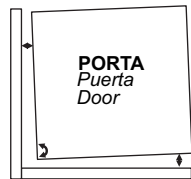
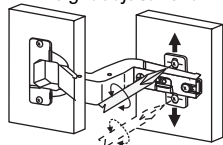

AJUSTE INTERNO
Ajuste interno
Internal adjustment

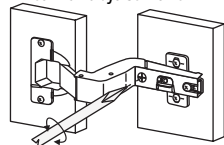

AJUSTE DE PROFUNDIDADE
Ajuste de profundidad
Depth adjustment

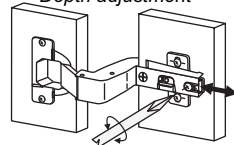

4

