

Capacidade de Carga - Load Capacity - Capacidad de carga

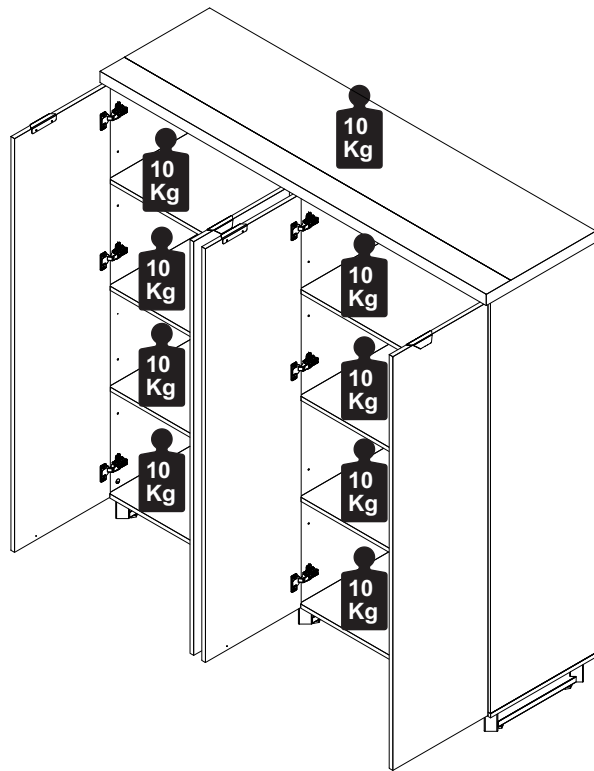

Manutenção e Limpeza

Vidros: pano levemente umedecido com álcool, seguido de pano seco.
Madeiras: pano levemente umedecido com água, seguido de pano seco.
*Nunca utilizar produtos químicos ou abrasivos.

Maintenance and Cleaning

Glasses: cloth lightly moistened with alcohol, followed by dry cloth.
Woods: cloth slightly moistened with water, followed by cloth seco.
*Never use chemicals or abrasives.

Mantenimiento y Limpieza

Vidrios: legeramente humedecido con alcohol, seguido de un paño seco.
Madera: ligeramente humedecido con agua, seguido de un paño seco.
*No utilice nunca productos quimicos o abrasivos.

INSTRUÇÕES DE MONTAGEM ASSEMBLY INSTRUCTIONS INSTRUCCIONES DE MONTAJE

ARMÁRIO BAIXO DUPLO

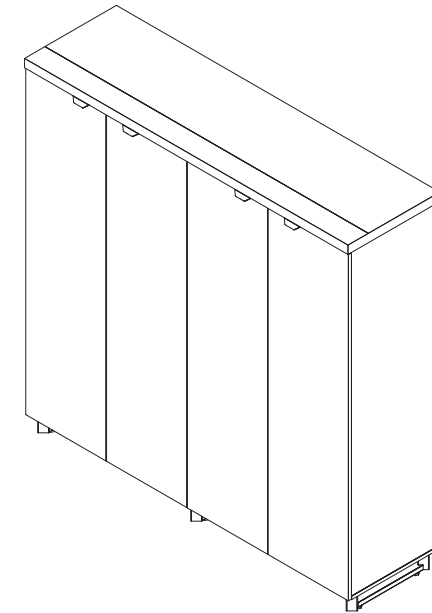

REF. #BOS1616

 **Gebbwork**
MOBILIÁRIO
PARA ESCRITÓRIO

GEBB Work Ind. de Móveis Ltda.
Rua Felix Roman, 190
São Valentin
95709-170 - Bento Gonçalves - RS - Brasil Fone: (0XX54) 3454-1105 - (0XX54) 3453-1407 Phone: (0XX54) 3454-1105 - (0XX54) 3453-1407 E-mail: pedidos@gebbwork.com.br
www.gebbwork.com.br
WhatsApp: +55 54 99177-8324
REV.: 01 - 21/04/2025



LISTA DE PEÇAS

PART LIST LISTA DE PIEZAS

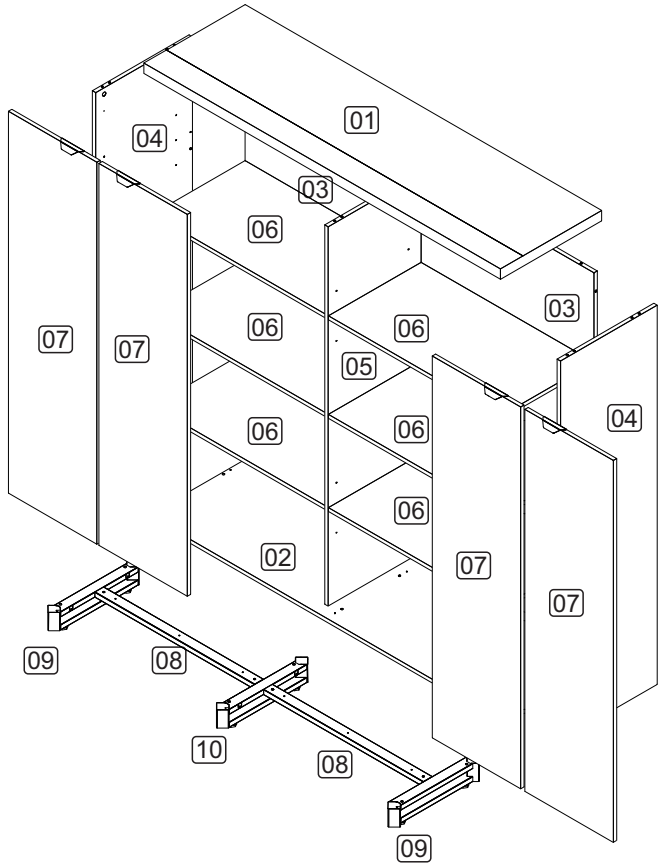

LISTA DE PEÇAS

LISTA DE PIEZAS

PARTS IDENTIFICATION

01 - Tampo (1x)	01 - Tapa (1x)	01 - Top Panel (1x)
02 - Base (1x)	02 - Base (1x)	02 - Bottom Panel (1x)
03 - Costa (2x)	03 - Revés (2x)	03 - Back Panel (2x)
04 - Lateral Dir/Esq (2x)	04 - Lateral Derecha/Izquierda (2x)	04 - Right/Left Side Panel (2x)
05 - Divisória (1x)	05 - Divisor (1x)	05 - Divider (1x)
06 - Prateleira Móvel (6x)	06 - Plataforma Mueve (6x)	06 - Mobile Shelf (6x)
07 - Porta (4x)	07 - Puerta (4x)	07 - Door (4x)
08 - Longarina Rodapé (2x)	08 - Larguero (2x)	08 - Metal Spar (2x)
09 - Rodapé Metálico Lat (2x)	09 - Zócalo Lateral (2x)	09 - Side Metal Skirting Board (2x)
10 - Rodapé Metálico Cen (1x)	10 - Zócalo Central (1x)	10 - Central Metal Skirting Board (1x)

ACESSÓRIOS

ACCESSORIES ACCESORIOS

A8 - PARAF. 4,0x14 CP
80x



A35 - TAMBOR MINIFIX
30x



D3 - CAVILHA 8x50
4x

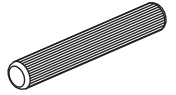

G1 - DOBRADIÇA CANECO 35 BAIXO
4x

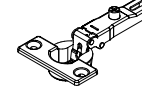

D1 - CAVILHA 8x30
28x

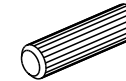

A55 - HASTE MINIFIX DUPLA P/18mm
4x

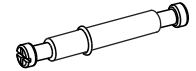

B1 - SUPORTE PRAT. METÁLICO
24x

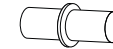

A13 - PARAF. 4,0x30 CP
6x



L5 - BUCHA PLÁSTICA P/SAPATA 5/16
6x



A32 - PARAF. MINIFIX
22x

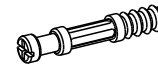

A44 - PARAF. M6x16 CP
04x



L2 - SAPATA PLAST. SEXT.
6x



C11 - PUXARDOR MET. BOSS
4x

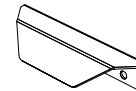

G6 - DOBRADIÇA CANECO 35 COLO ALTO
4x



1 PRÉ-MONTAGEM

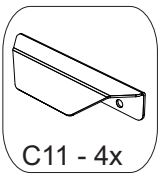
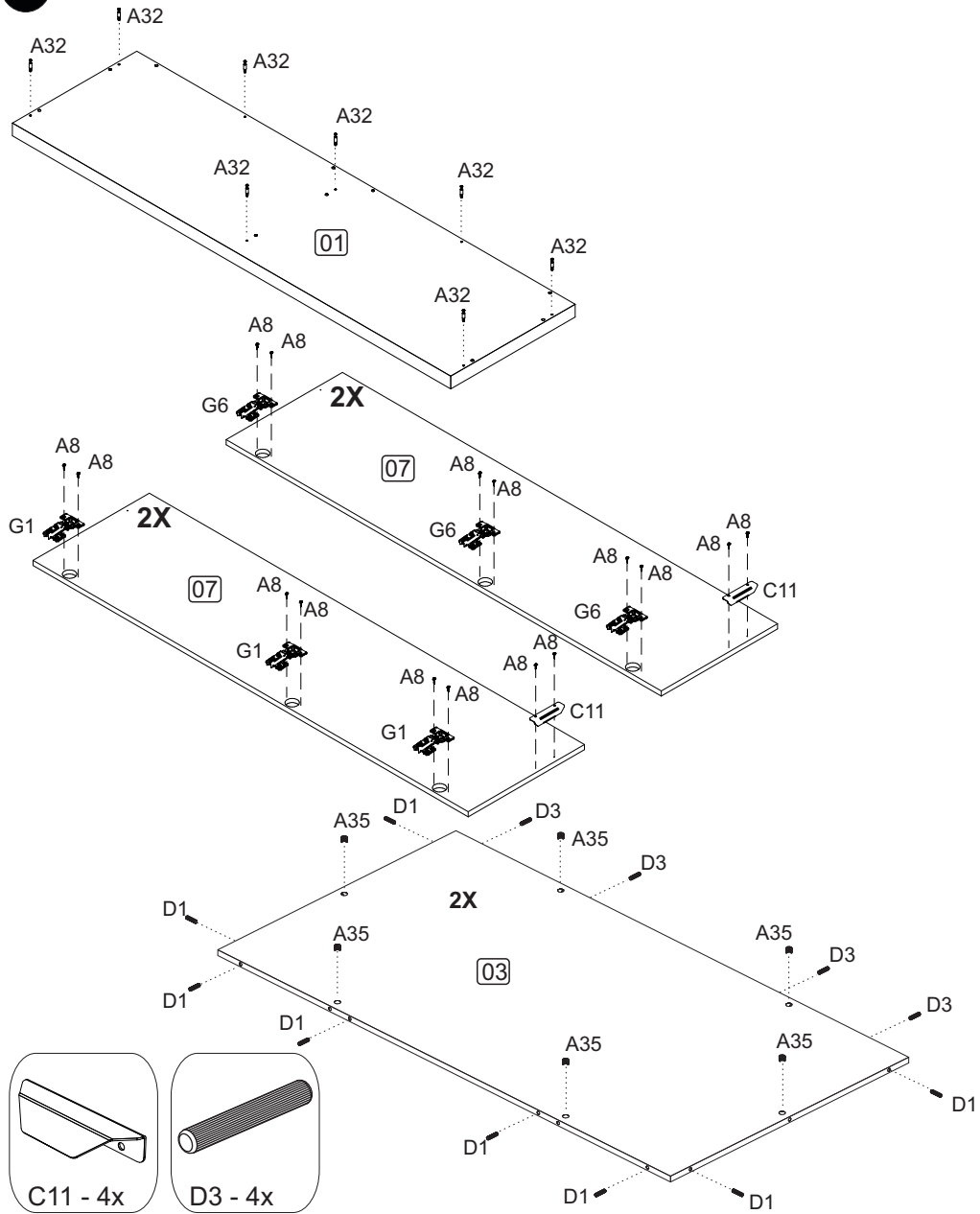

C11 - 4x

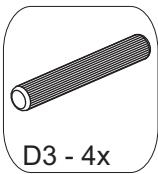

D3 - 4x

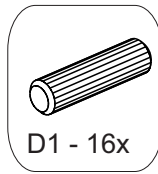

D1 - 16x



G6 - 4x



A32 - 8x



A35 - 20x

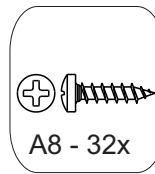

A8 - 32x

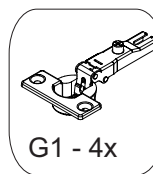

G1 - 4x

2 MONTAGEM

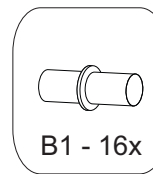
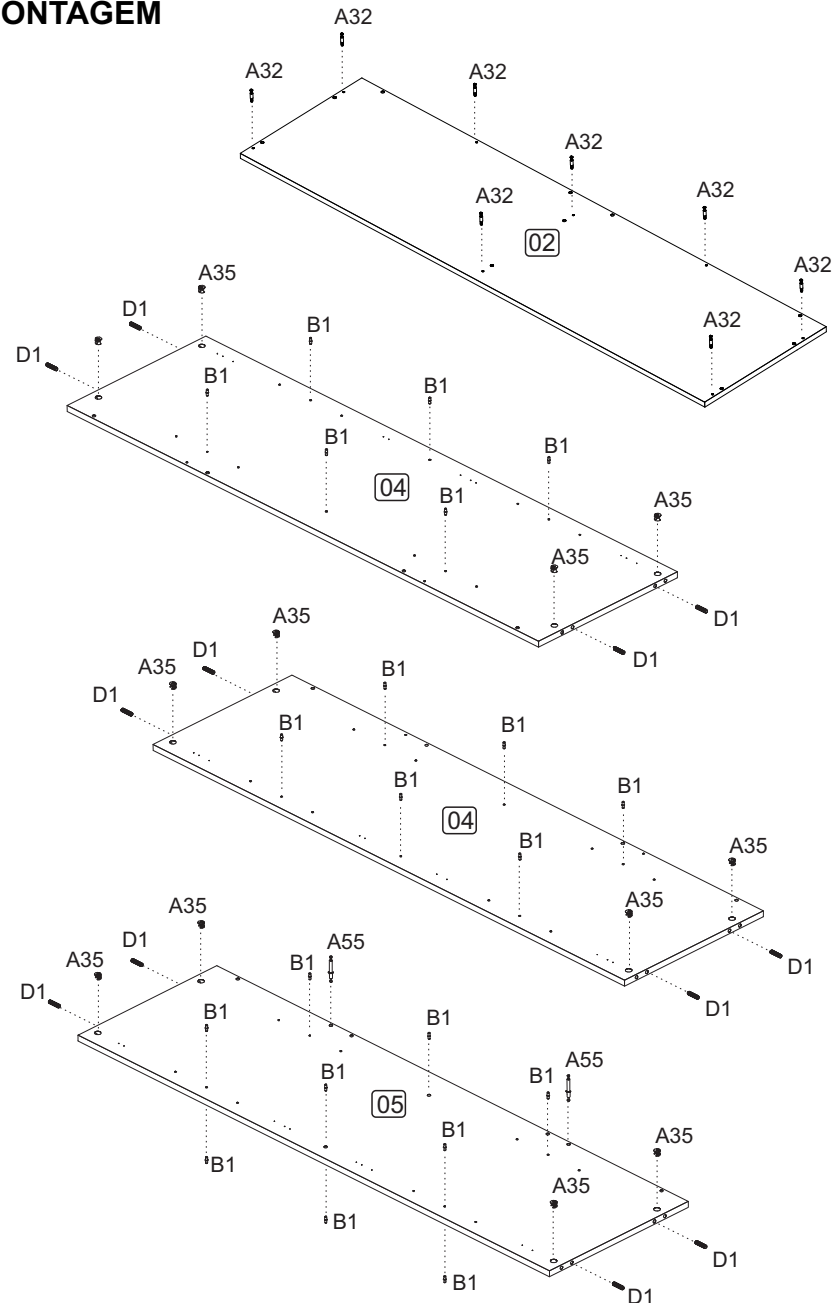

B1 - 16x

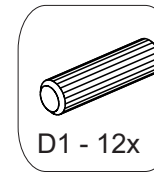

D1 - 12x

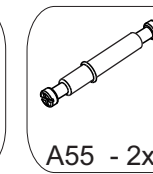

A55 - 2x



A35 - 12x

3

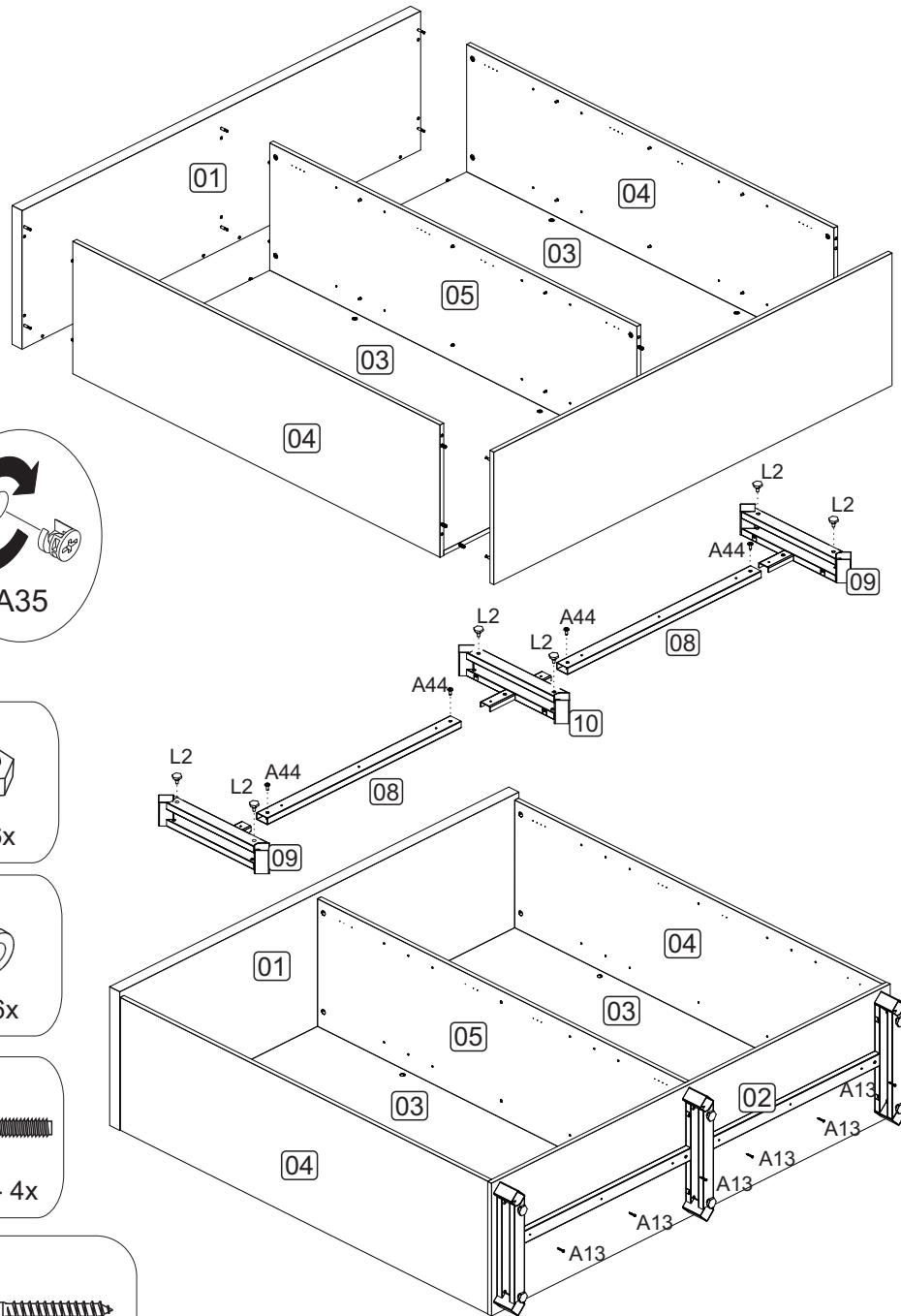

A35



L2 - 6x



L5 - 6x



A44 - 4x



A13 - 6x

4

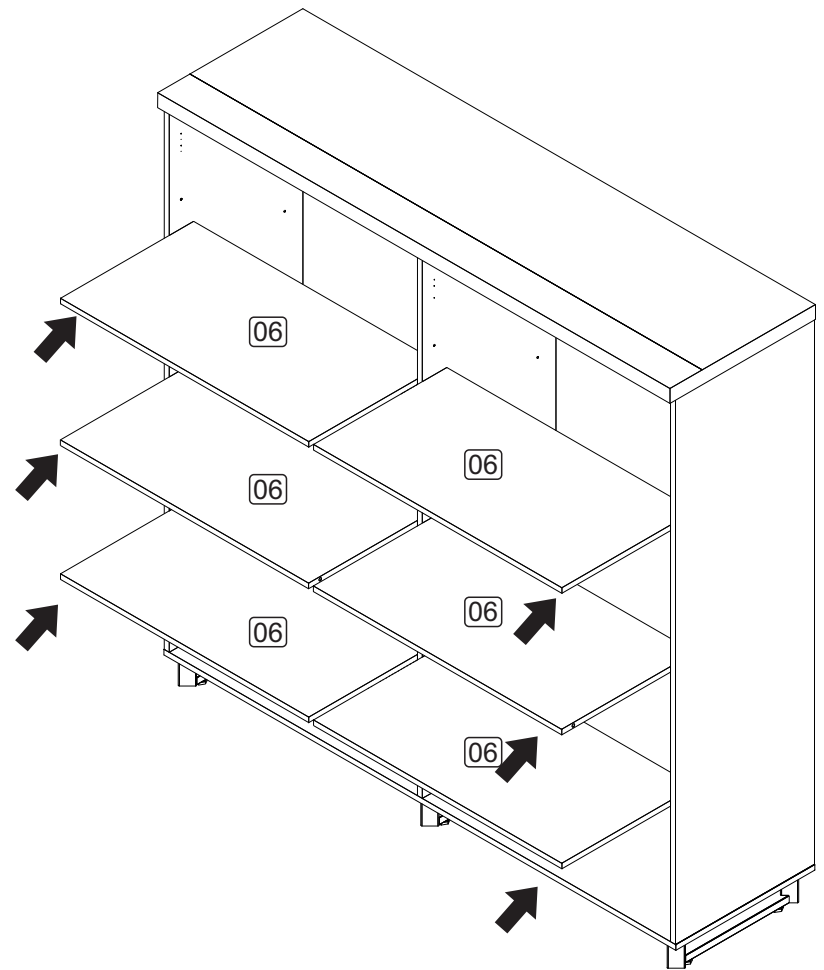

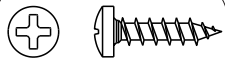
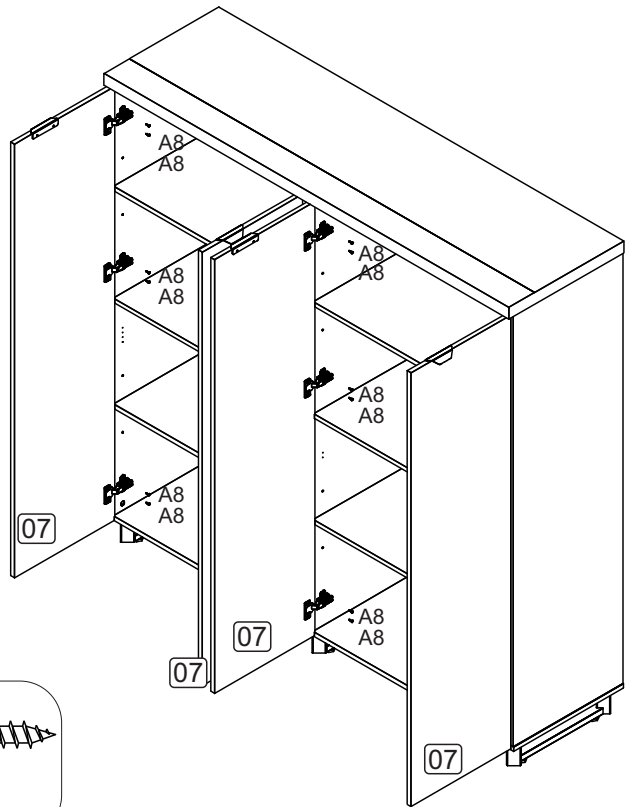

A8 - 24x

AJUSTE DAS PORTAS

Ajuste de puerta

Door adjustment

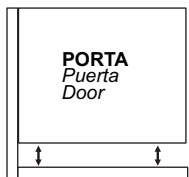

PORTA
Puerta
Door

AJUSTE DE ALTURA
Ajuste de altura
Height adjustment

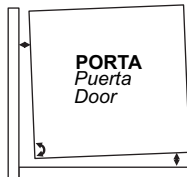
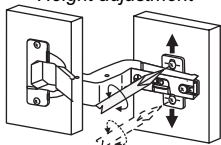

PORTA
Puerta
Door

AJUSTE INTERNO
Ajuste interno
Internal adjustment

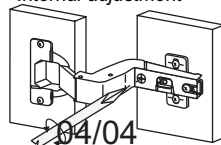

04/04



PORTA
Puerta
Door

AJUSTE DE PROFUNDIDADE
Ajuste de profundidad
Depth adjustment

