

Capacidade de Carga - Load Capacity - Capacidad de carga

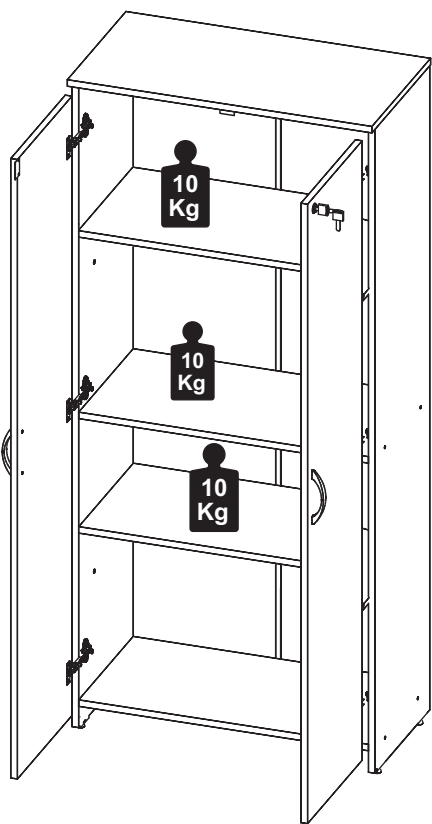

Manutenção e Limpeza

Vidros: pano levemente umedecido com álcool, seguido de pano seco.
Madeiras: pano levemente umedecido com água, seguido de pano seco.
*Nunca utilizar produtos químicos ou abrasivos.

Maintenance and Cleaning

Glasses: cloth lightly moistened with alcohol, followed by dry cloth.
Woods: cloth slightly moistened with water, followed by cloth seo.
*Never use chemicals or abrasives.

Mantenimiento y Limpieza

Vidrios: legeramente humedecido con alcohol, seguido de un paño seco.
Madera: ligeramente humedecido con agua, seguido de un paño seco.
*No utilice nunca productos quimicos o abrasivos.

INSTRUÇÕES DE MONTAGEM ASSEMBLY INSTRUCTIONS INSTRUCCIONES DE MONTAJE

ARMÁRIO ALTO HIGT CABINET ARMARIO ALTO

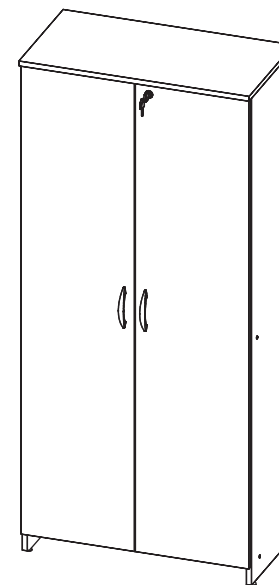

REF. #0316



MOBILIÁRIO
PARA ESCRITÓRIO

GEBB Work Ind. de Móveis Ltda.
Rua Felix Roman, 190
São Valentin

95709-170 - Bento Gonçalves - RS - Brasil
Fone: (0XX54) 3454-1105 - (0XX54) 3453-1407
Phone: (0XX54) 3454-1105 - (0XX54) 3453-1407
E-mail: pedidos@gebbwork.com.br
www.gebbwork.com.br
WhatsApp: +55 54 99177-8324



LISTA DE PEÇAS

LISTA DE PEÇAS

- 01 - Lateral Esquerda
- 02 - Lateral Direita
- 03 - Tampo
- 05 - Prateleira Móvel
- 06 - Porta Esquerda
- 07 - Porta Direita
- 08 - Costa
- 09 - Base
- 10 - Perfil H

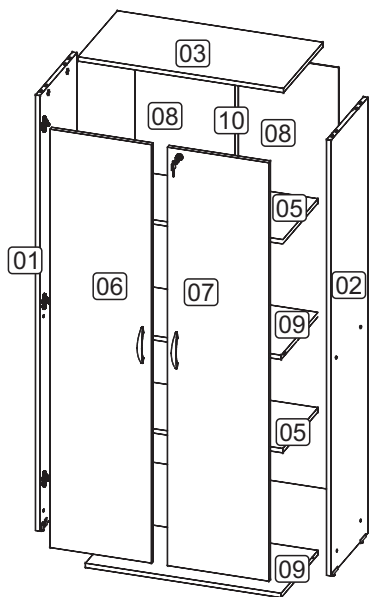

LISTA DE PIEZAS

- 01 - Lateral Izquierda
- 02 - Lateral Derecha
- 03 - Tapa
- 05 - Repisa Móvil
- 06 - Puerta Izquierda
- 07 - Puerta Derecha
- 08 - Revés
- 09 - Base
- 10 - Perfil H

PARTS IDENTIFICATION

- 01 - Left Side
- 02 - Right Side
- 03 - Top
- 05 - Mobile Shelf
- 06 - Left Door
- 07 - Right Door
- 08 - Back
- 09 - Base
- 10 - Profile H

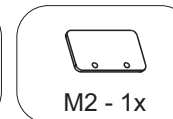
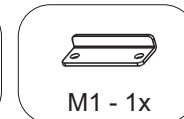
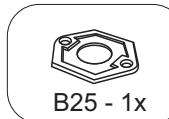
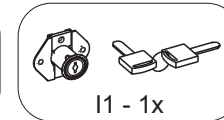
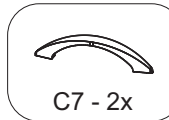
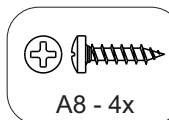
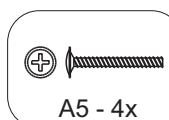
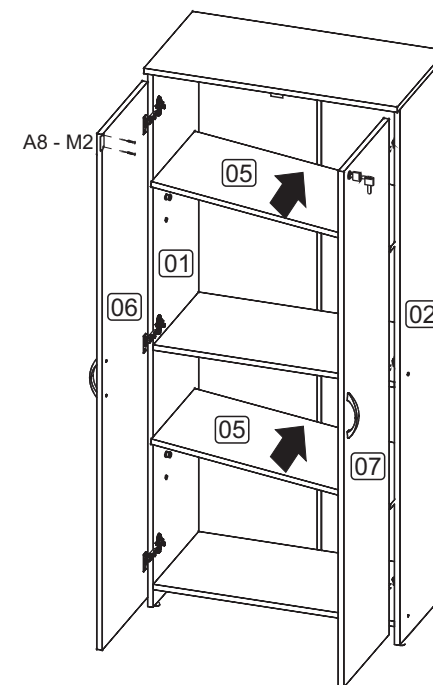
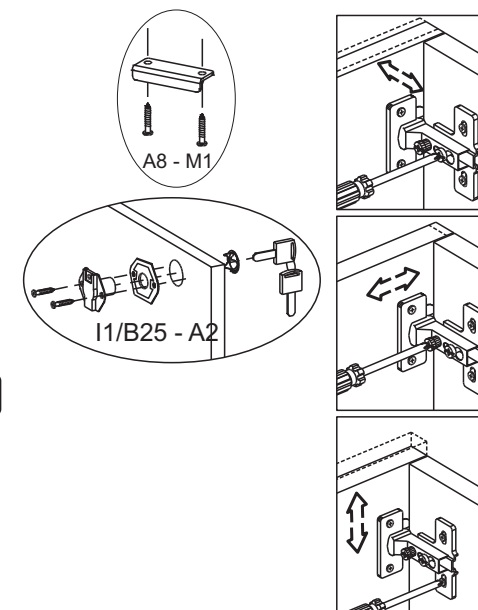
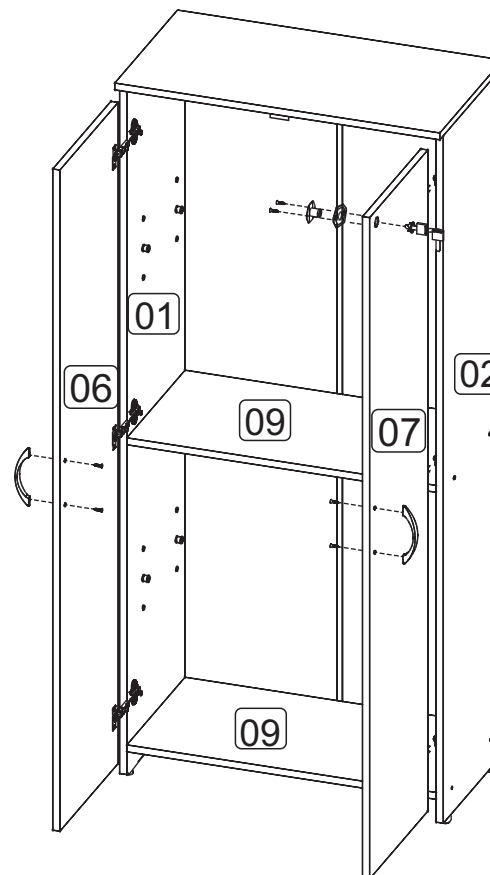

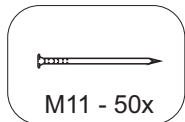
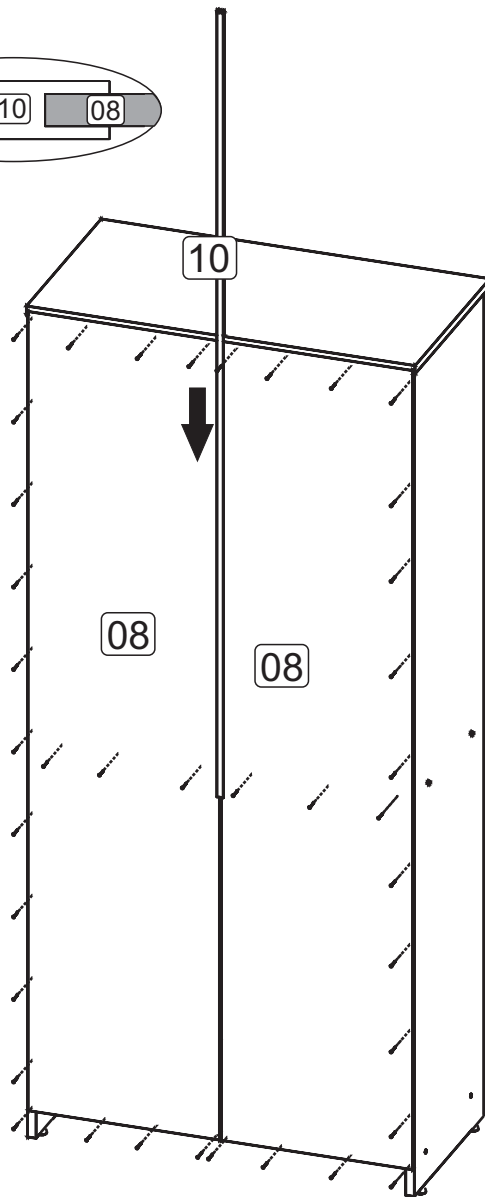
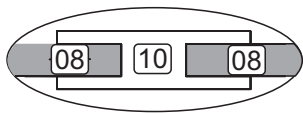

ACESSÓRIOS ACCESSORIES ACCESORIOS

A5 - PARAF. 3,5x25 CF
4x



A8 - PARAF. 4,0x14 CP
30x



A32 - PARAF. MINIFIX
4x

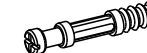

A17 - PARAF. 4,0x45 CF
8x



A35 - TAMBOR MINIFIX
4x



B2 - SUPORTE PRAT.
8x7 **08x**



C7 - PUXADOR
2x



D1 - CAVILHA 8x30
12x

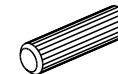

G1 - DOBRADIÇA
CANECO 35 BAIXO **6x**



G2 - CALÇO ALTO P/
DOBRADIÇA **6x**



I1 - FECHADURA P/GAV.
1x



B25 - SEPARADOR PARA
FECHADURA **1x**



L3 - SAPATA PLAST.1/4
4x



M3 - CHAPA P/SAPATA
1/4" **4x**



M1 - CHAPA L 2 FUROS
OBL 42x17x0,9mm ZB **1x**



M2 - BATENTE P/PORTA
2F 48x24x1,5mm ZB **1x**



M11 - PREGO 10x10
50x



A3 - PARAF. 3,5x20 CP
8x



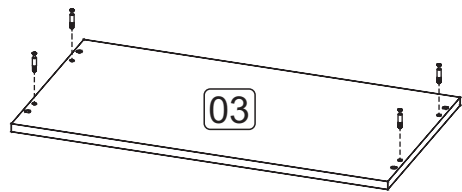

03

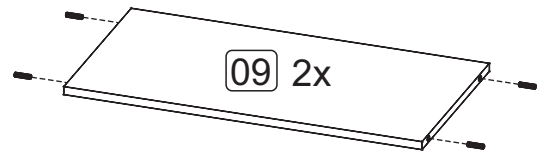

09 2x

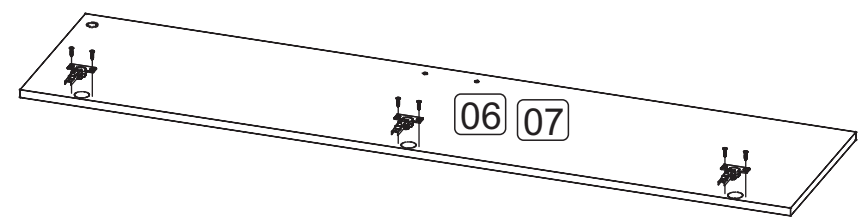

06 07

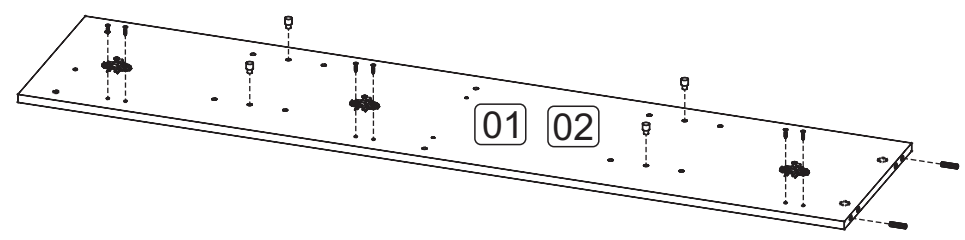

01 02

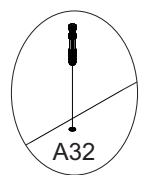

A32

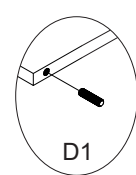

D1

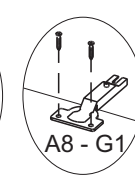

A8 - G1

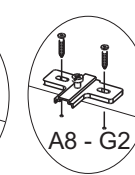

A8 - G2

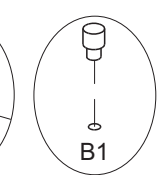

B1

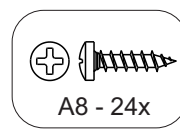

A8 - 24x

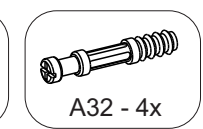

A32 - 4x

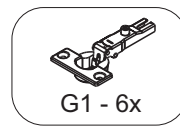

G1 - 6x

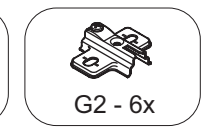

G2 - 6x

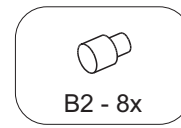

B2 - 8x

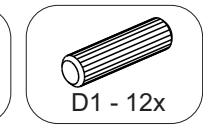

D1 - 12x

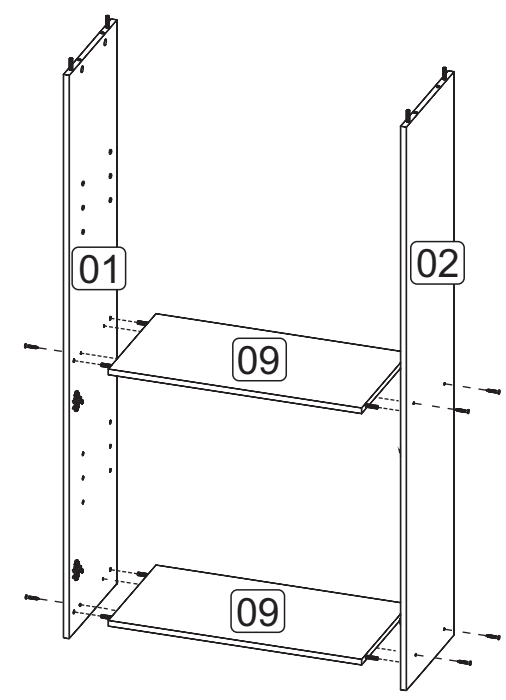

01

02

09

09

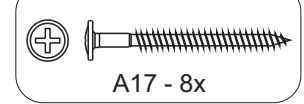

A17 - 8x

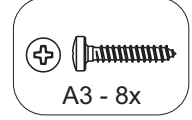

A3 - 8x

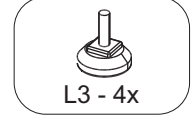

L3 - 4x

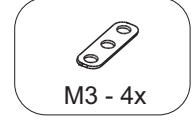

M3 - 4x



A35 - F1

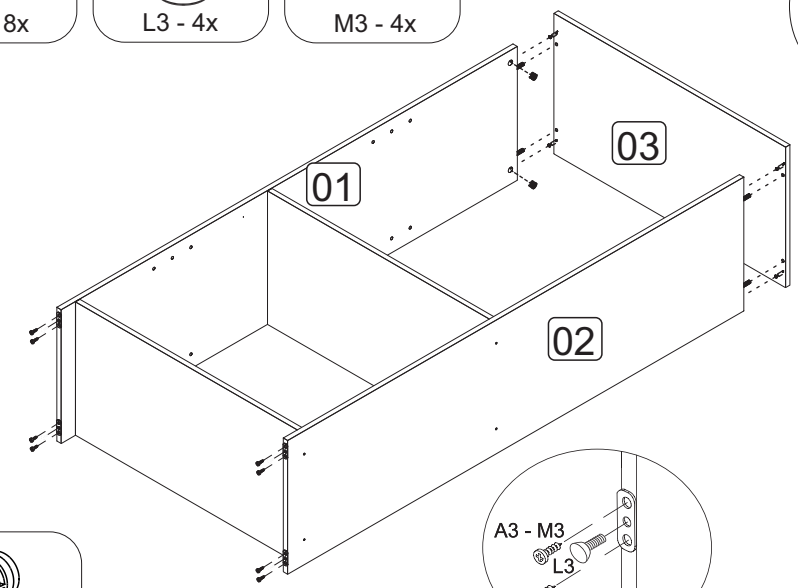

01

03

02

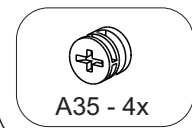

A35 - 4x

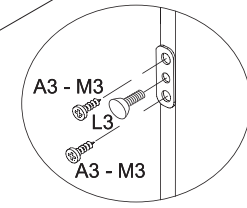

A3 - M3
L3
A3 - M3