

INSTRUÇÕES DE MONTAGEM
ASSEMBLY INSTRUCTIONS
INSTRUCCIONES DE MONTAJE

**ARMÁRIO ESTANTE
SHELF CABINET
ARMARIO ESTANTE**

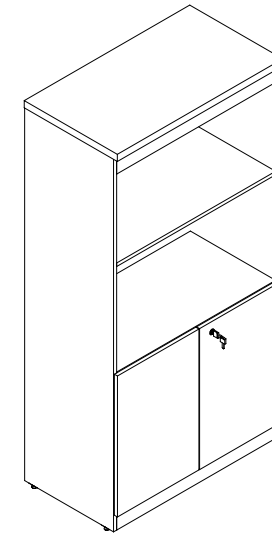

REF. #VRA8117



MOBILIÁRIO
PARA ESCRITÓRIO

GEBB Work Ind. de Móveis Ltda.
Rua Felix Roman, 190
São Valentin

95709-170 - Bento Gonçalves - RS - Brasil
Fone: (0XX54) 3454-1105 - (0XX54) 3453-1407
Phone: (0XX54) 3454-1105 - (0XX54) 3453-
1407 E-mail: pedidos@gebbwork.com.br
www.gebbwork.com.br
WhatsApp: +55 54 99177-8324



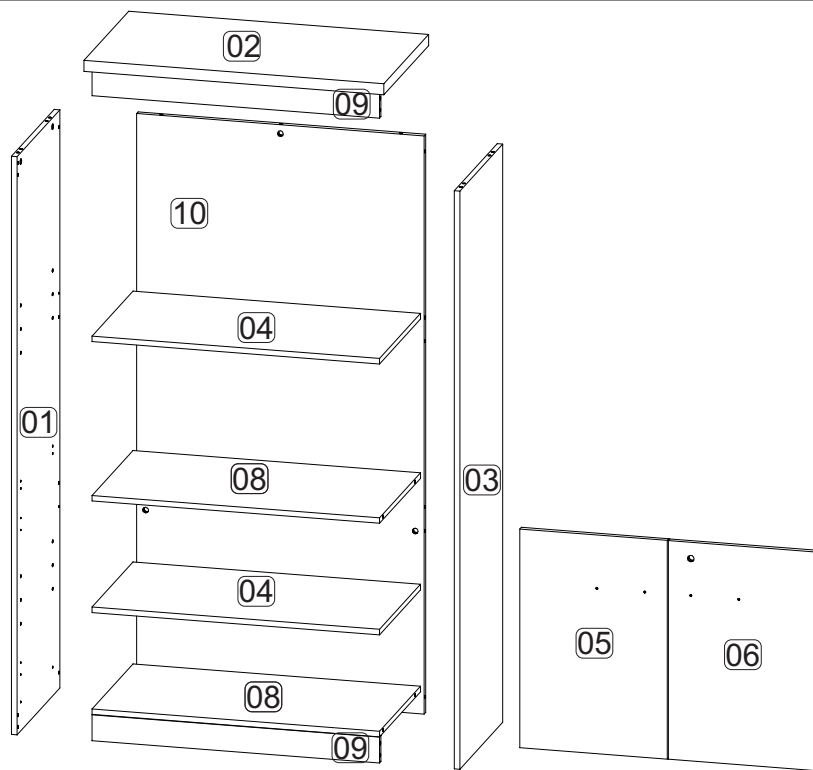

LISTA DE PEÇAS

01 Lateral Esquerda	(1x)
02 Tampo Engros. 30mm	(1x)
03 Lateral Direita	(1x)
04 Prateleira Móvel	(2x)
05 Porta Esquerda	(1x)
06 Porta Direita	(1x)
08 Prateleira Fixa	(2x)
09 Rodapé	(2x)
10 Costa	(1x)

LIST OF PIECES

01 Left Side	(1x)	02 Tapa 30mm	(1x)
03 Right Side	(1x)	03 Lateral Derecha	(1x)
04 Mobile Shelf	(2x)	04 Estante Móvil	(2x)
05 Left Door	(1x)	05 Puerta Izquierda	(1x)
06 Right Door	(1x)	06 Puerta Derecha	(1x)
08 Fixed Shelf	(2x)	08 Estante Fijo	(2x)
09 Footer	(2x)	09 Pie	(2x)
10 Coast	(1x)	10 Costa	(1x)

LISTA DE PIEZAS

3

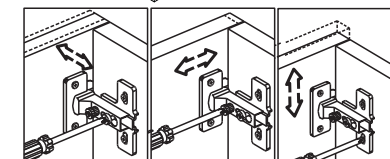
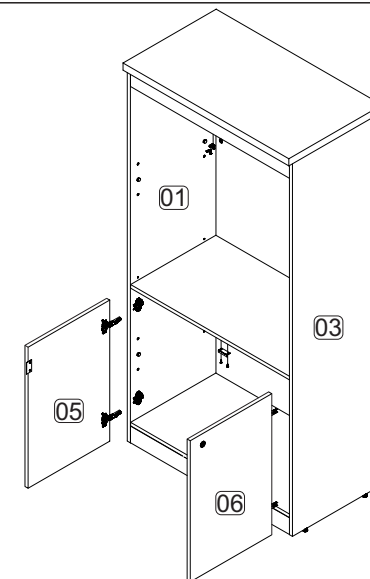
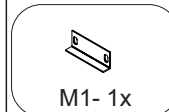
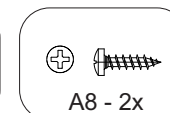
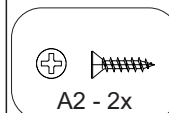
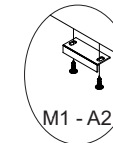

4

COM RODAPÉ

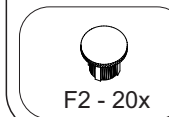
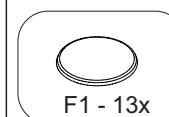
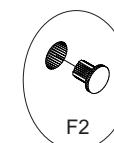
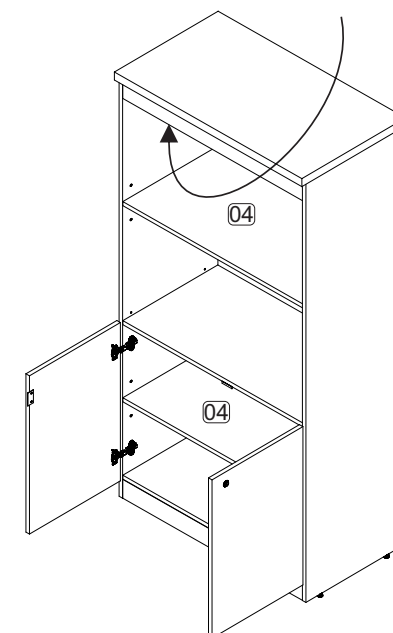

Capacidade de Carga - Load Capacity - Capacidad de carga

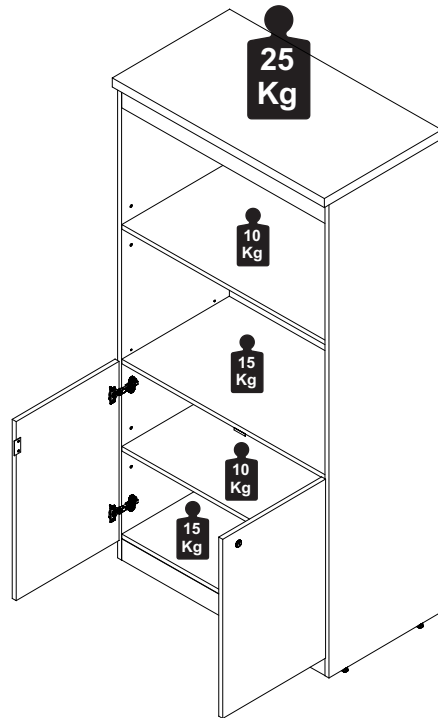

Manutenção e Limpeza

Vidros: pano levemente umedecido com álcool, seguido de pano seco.
 Madeiras: pano levemente umedecido com água, seguido de pano seco.
 *Nunca utilizar produtos químicos ou abrasivos.

Maintenance and Cleaning

Glasses: cloth lightly moistened with alcohol, followed by dry cloth.
 Woods: cloth slightly moistened with water, followed by cloth seco.
 *Never use chemicals or abrasives.

Mantenimiento y Limpieza

Vidrios: legeramente humedecido con alcohol, seguido de un paño seco.
 Madera: ligeramente humedecido con agua, seguido de un paño seco.
 *No utilice nunca productos quimicos o abrasivos.

ACESSÓRIOS ACCESSORIES ACCESORIOS

A2 - PARAF. 3,5x14 CC
6x

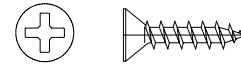

M9 - CANTONEIRA L
 02 FUROS **2x**



A8 - PARAF. 4,0x14 CP
36x

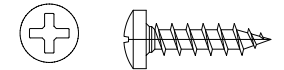

A32 - PARAF. MINIFIX
17x

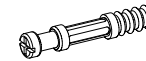

A35 - TAMBOR
 MINIFIX **17x**



B2 - SUPORTE PRAT.
 PLÁST. 8x7 **8x**



F2 - TAPA FURO
 ENCAIXE ø8 **24x**



D1 - CAVILHA 8x30
30x

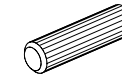

F1 - TAPA FURO ø18
13x

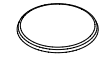

I1 - FECHADURA **1x**

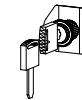

G1 - DOBRADIÇA
 CANECO 35 **4x**

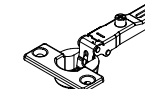

G2 - CALÇO P/
 DOBRAD. CANECO 35
4x



M1 - CHAPA L 02
 FUROS OBLONGO **1x**



L3 - SAPATA PLAST.1/4
4x



L15 - CANTONEIRA P/
 SAPATA 70X40X40 **4x**



B25 - SEPARADOR
 P/ FECHADURA **1x**



M5 - BATENTE P/
 PORTA 02 FUROS **1x**



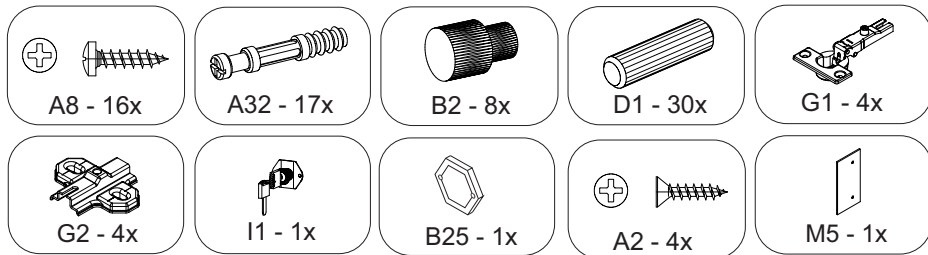
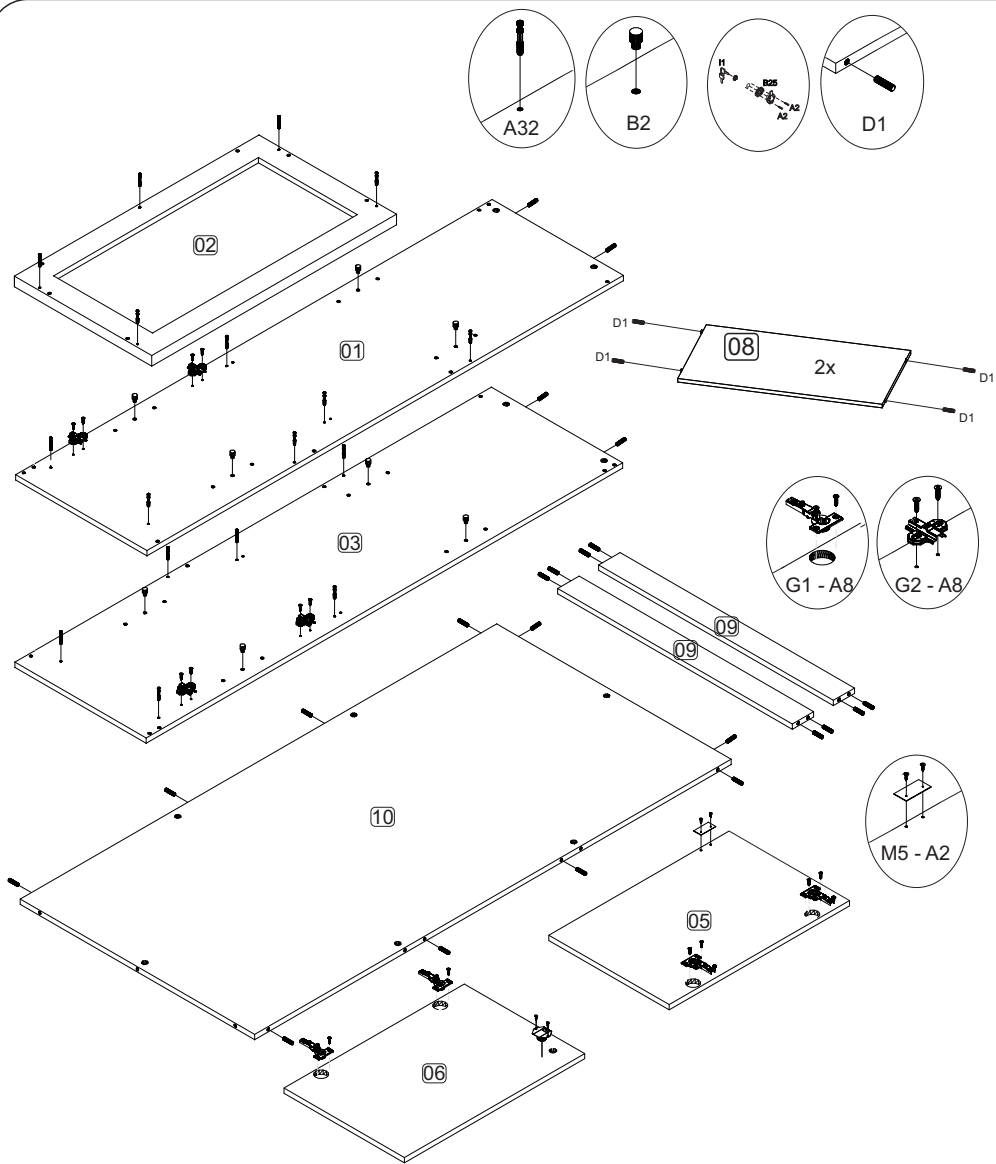

04/08

1

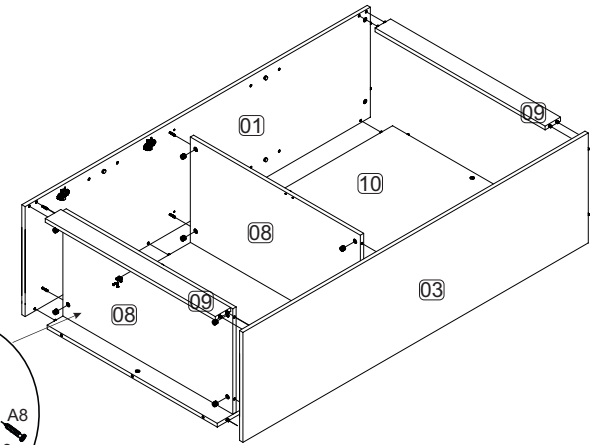

Fixe o parafuso A8 na parte superior da cantoneira L15.

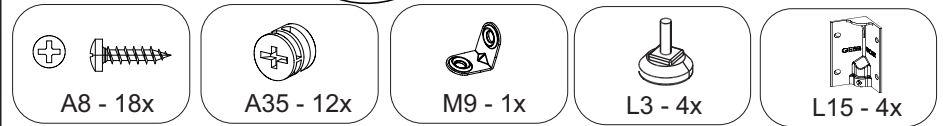
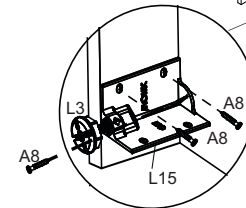

2

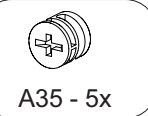
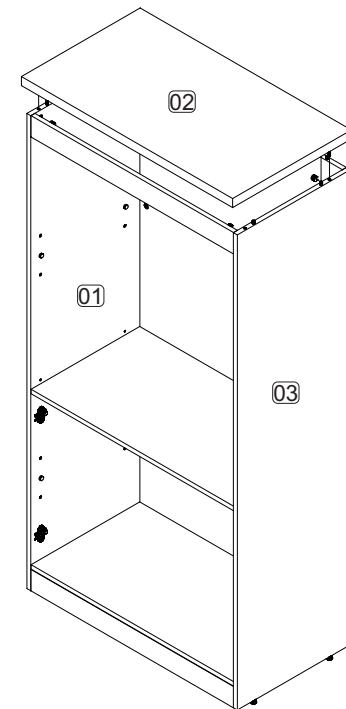

05/08